

Key information for builders and developers: Fibre ready pit and pipe for nbn™ New Developments Horizontal Multi Dwelling Units (HMDU)

Dwelling preparation requirements are to assist with the installation of the nbn™ access network technology being installed to the dwelling.

- 1 x internal P20 nominal rigid white telecommunications conduit installed from the nbn™ utility box, electrical enclosure location to a suitable location within the dwelling (see Figures 9 and 10).
- Dwellings constructed on new lots, HMDUs or that are street facing will require a lead-in. For an example of a lead-in see Figure 9.
 - Street frontage dwellings would require the lead-in from the dwellings proposed nbn™ utility box, electrical enclosure location, to the property's front boundary closest to an nbn™ pit.
 - Where the dwelling/s are located within an HMDU the lead-in would be installed from an internal pit (see Figures 13, 14 and 16) to the dwellings proposed nbn™ utility box, electrical enclosure location. Do not exceed the pits conduit or lead-in capacity (see Figure 4).
 - The lead-in conduit at the building entry point can be installed within the dwelling footings and exit the wall cavity at the proposed nbn™ utility box location, electrical enclosure location or the lead-in can be surface mounted over the dwelling footings and up the external wall to the proposed nbn™ utility box, electrical enclosure location. See Figures 1 and 2.
- Pit types available for selection: type 2, type 5, type 6, type 8. All pits to contain pit lid gaskets. All pit lids to be branded NBN as per NBN-TE-CTO-194.

- Conduit entry into pits is important; good examples are shown in Figures 5, 6 and 7. Do not install conduits into the longest side of a pit Figure 8.
- No more than two 300mm radius 90° underground bends from the pit to the nbn™ utility box location and one aboveground 100mm radius 90° bend can be used between draw points. A maximum of three bends in total. See Figure 1, 2, 9 and 10.
- All conduit fittings and joins must be glued using solvent cement.
- Lead-in conduits installed into the dwelling footings rising up into the wall cavity must not terminate in the wall cavity; the conduit must exit the wall cavity using a 100mm radius 90° bend unbroken as per Figure 3. Any lead-in conduit terminating within the wall cavity should be discarded. Lead-in conduits terminating within a wall cavity could allow the ingress of water, moisture or insects into the wall cavity.
 - In this case the lead-in must be intercepted before the footings and redirected as surface conduit to the nbn™ utility box, electrical enclosure location. For an example of a surface mounted lead-in see Figure 4.
- Flexible conduit must not be used underground, or in wall or ceiling cavities.
- It is the developer / builder's responsibility to ensure where the building entry point is lower than the street conduit a drainage pit may be required near the dwelling.

Figure 1

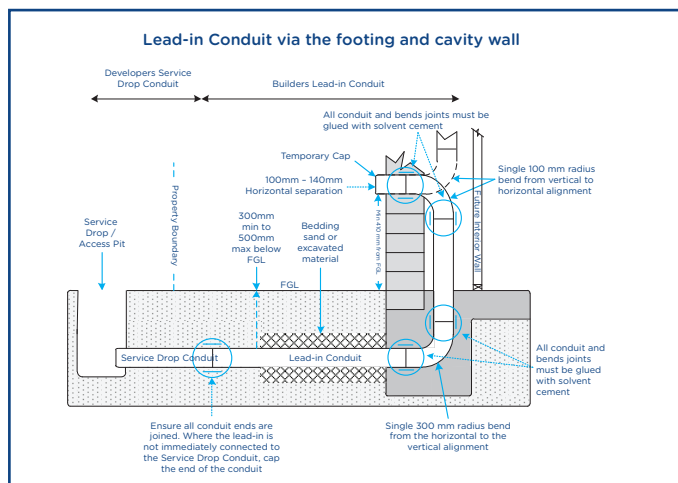

Figure 2

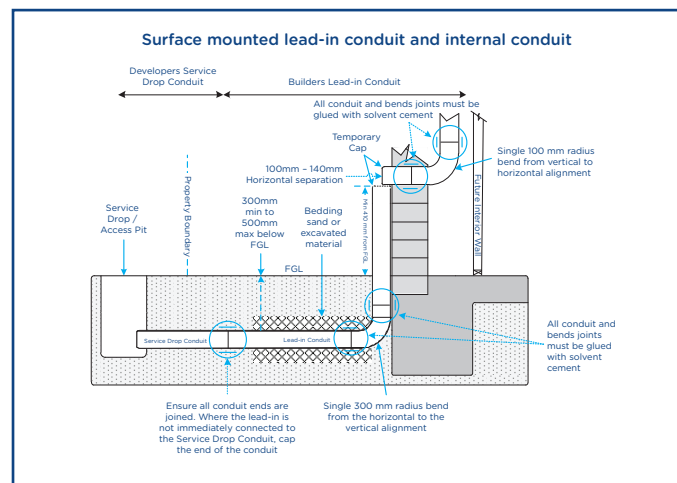

Figure 3

Conduit dimensions white telecommunications	Nominal Size (Inside Diameter)	Conduit dimensions white telecommunications	Nominal Size (Inside Diameter)	Conduit dimensions white telecommunications	Nominal Size (Inside Diameter)
<p>Nominal dimensions (in mm.)</p>	20 mm PN 12 AS/NZS 1477:2006 table 4.2(A)	<p>Nominal dimensions (in mm.)</p>	50 mm PN 12 ASPN 12 A S/NZS 1477:2006 table 4.2(A)	<p>Nominal dimensions (in mm.)</p>	100 mm PN 9 AS/ NZS 1477:2006 table 4.2(A)

Figure 4

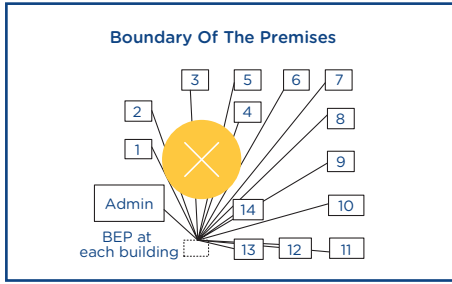

Figure 5

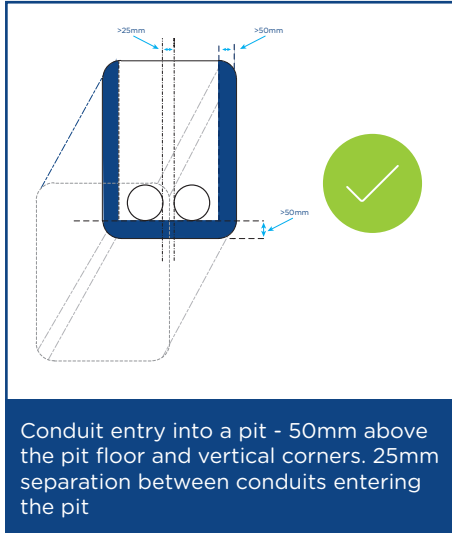

Figure 6

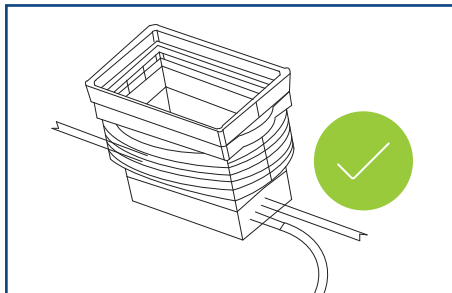

Figure 7

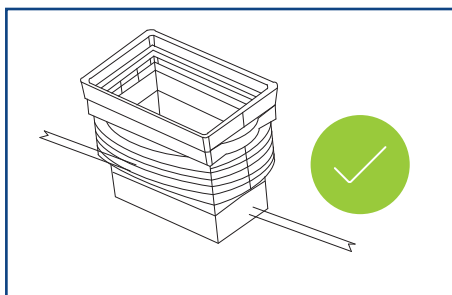

Figure 8

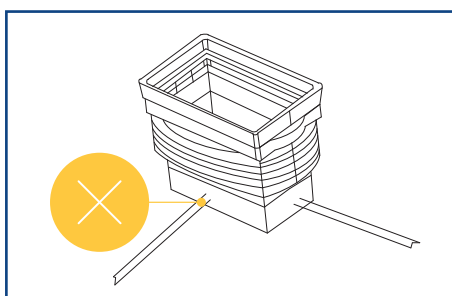

Figure 9

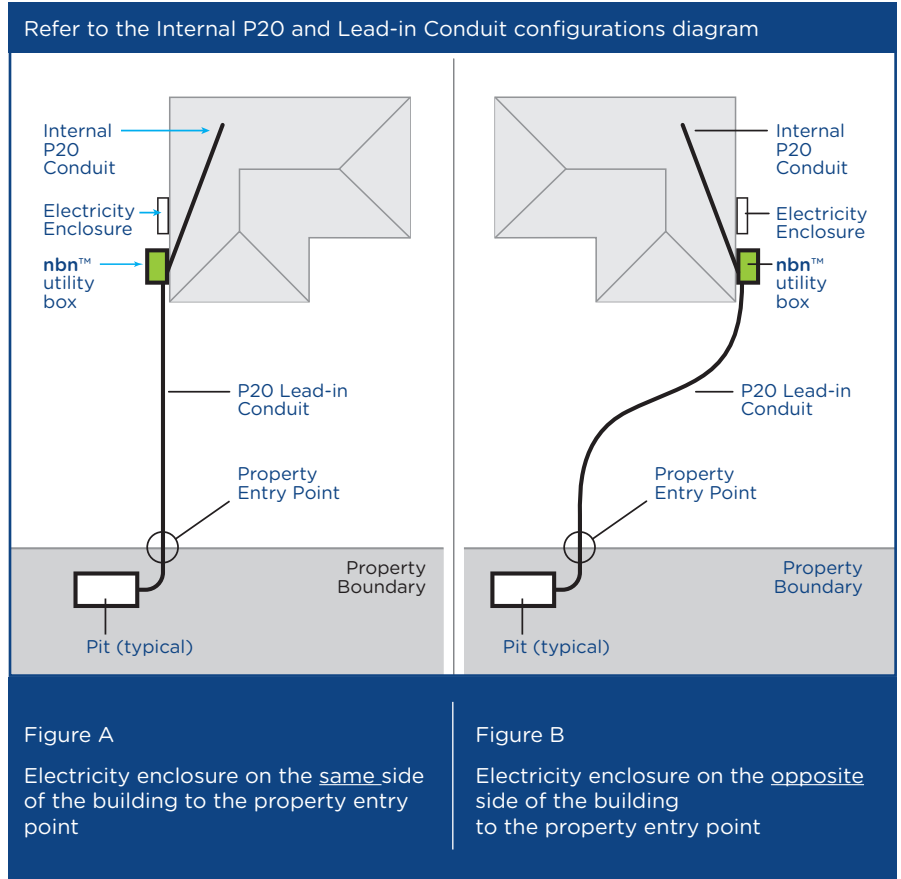
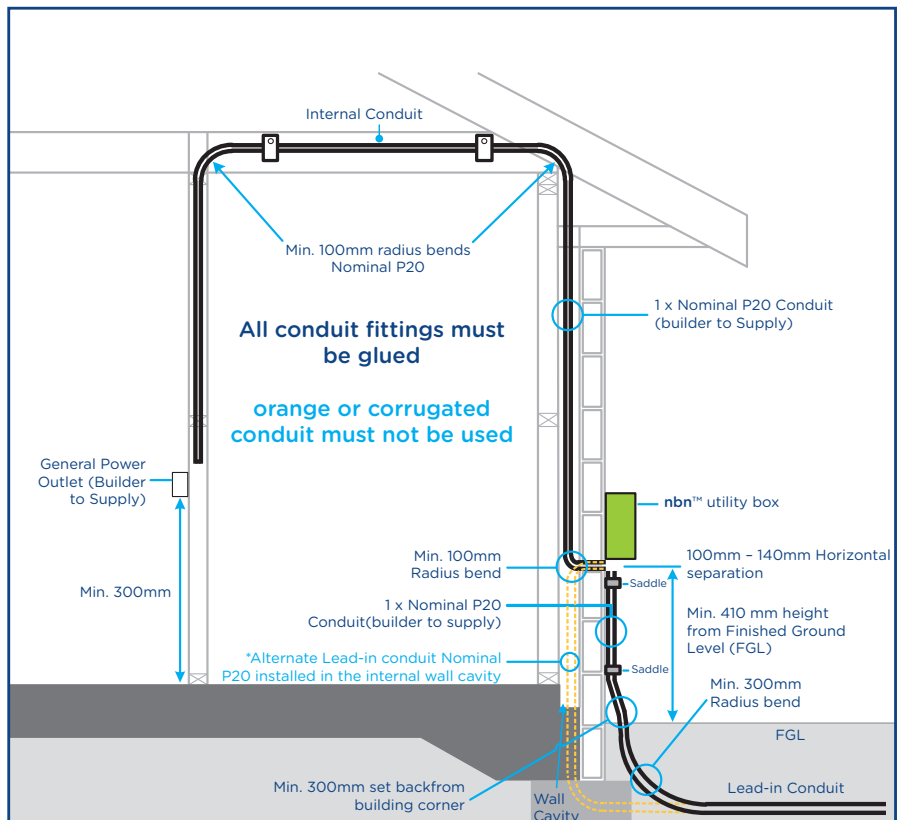

Figure 10



Key information for builders and developers: Fibre ready pit and pipe for nbn™ New Developments Horizontal Multi Dwelling Unit (HMDU)

This document should be read in conjunction with the following documents for new developments pit and pipe requirements:

- NBN-TE-CTO-194: New developments deployment of the nbn™ pit and conduit access network.
- NBN-DES-STD-0011: Preparation and Installation Guide - SDUs and MDUs.
- G645 Communications Alliance Ltd: Fibre-ready Pit and Pipe Specifications for Real Estate Development Projects.

Important items to remember:

All new lots or subdivided existing lots require fibre ready facilities (pit and pipe). All P100 and P50 conduit must be roped. P20 conduit must be strung and tagged. All conduit entering pits must be fitted with the appropriate sized bush. All conduits shall be plugged as per NBN-TE-CTO-194. This could be in the form of internal reticulated pit and pipe with service drop conduits; generally in Horizontal Multi Dwelling Unit sites (HMDU) are 4 units / townhouses or more.

- HMDU internal reticulated conduit between pits for 3 to 24 units / townhouses shall be P50. See Figure 3 for all conduit dimensions.
- HMDU internal reticulated conduit between pits for 25 or more units / townhouses shall be P100.

- The developer is responsible for installing any new pit and pipe externally in the road reserve where the new lot/s are street facing, this pit and pipe must interconnect to the internal pit and pipe servicing the internal units / townhouses. See Figures 11, 13 and 17.
- Where existing suitable carrier network pit and pipe exists, any pits and service drop conduits requiring installation over the existing network to service the development and or any street fronting units / townhouses will be funded by the developer. See Figures 12, 14, 15, 16 and 18.

Note: Not all HMDU unit / townhouse pit and pipe configurations are represented; Figures 11 through 18 are examples only.

Figure 11: No existing network that meets fibre ready requirement

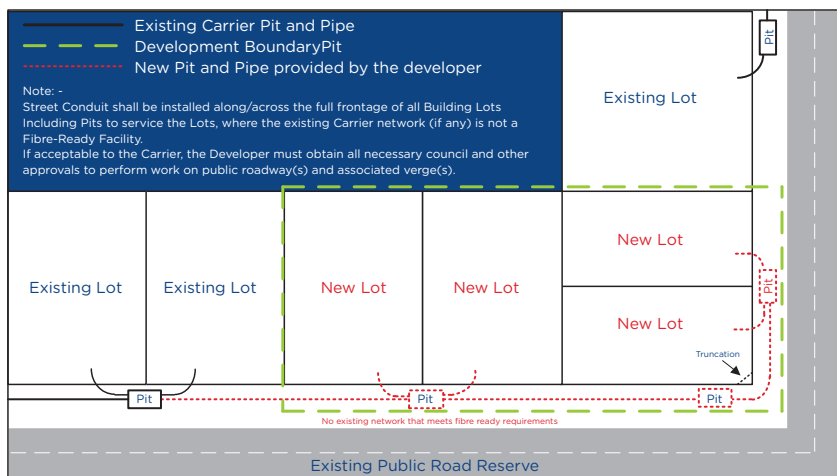

Figure 12: New pit/s and service drop conduit (provided by the carrier, funded by the developer)

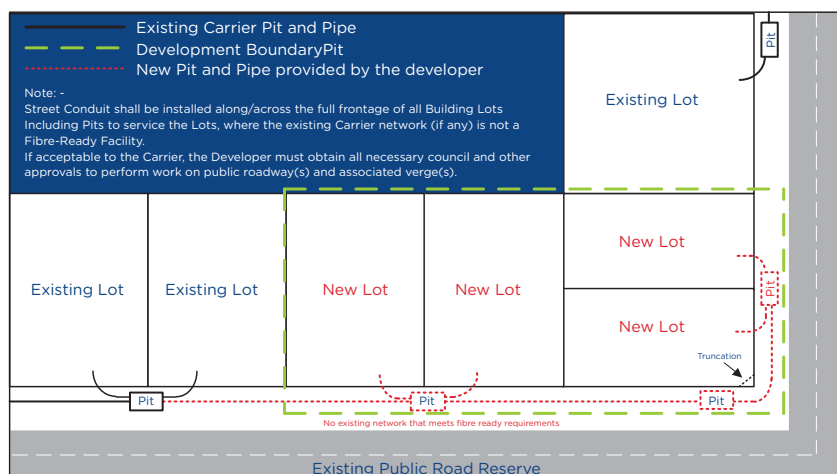

Figure 13

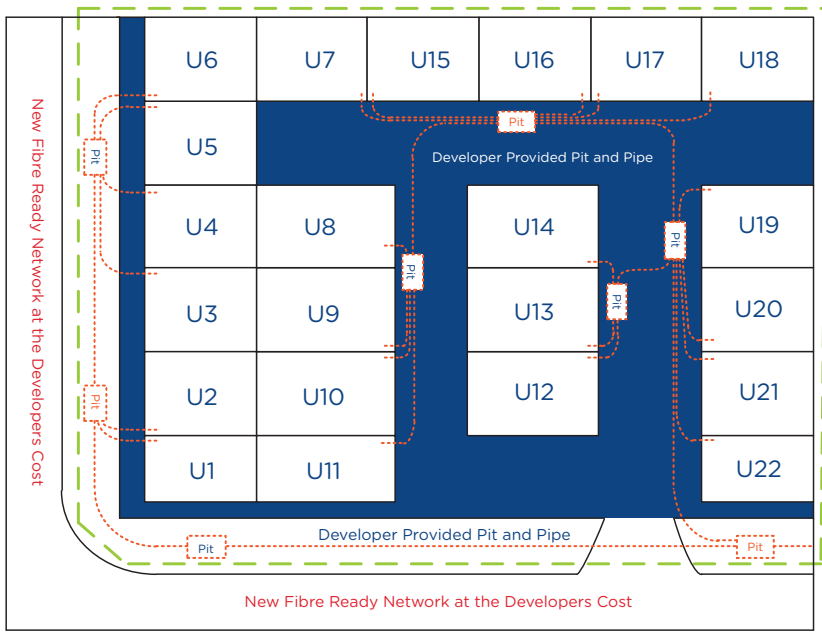

Figure 15

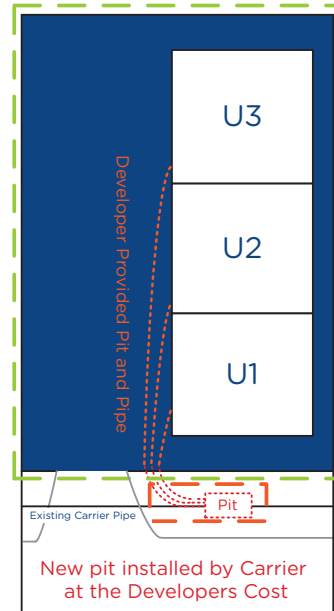

Figure 14

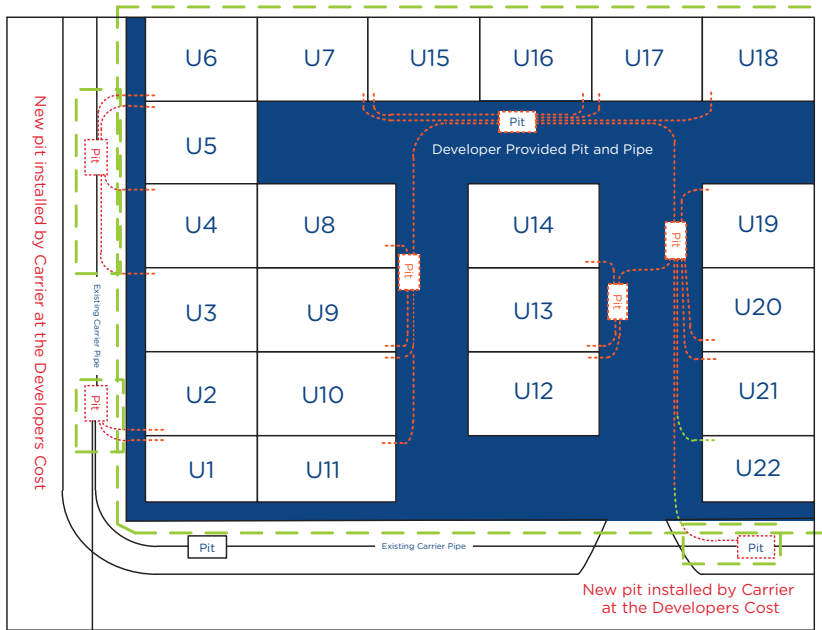

Figure 16

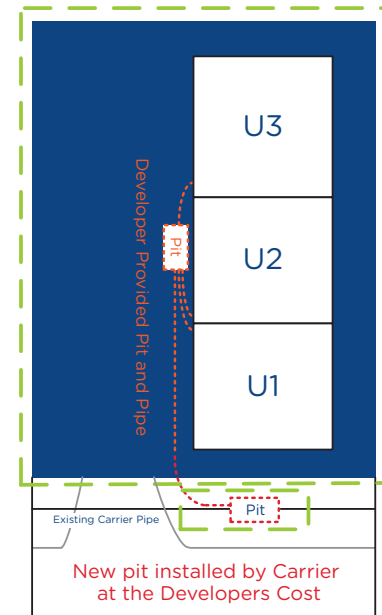

Figure 17

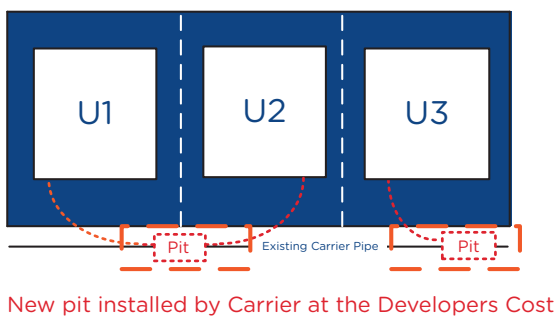

Figure 18

